

Technical Data Sheet

Positioner Type 824

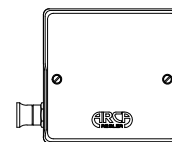

TD_824

General data

Mounting	On linear actuators	ARCA-integrated or acc. to IEC 534-6 (NAMUR) Range of stroke 10 ... 120 mm
	On quarter-turn actuators	ARCA-integrated or acc. to VDI/VDE 3845 Angle of rotation 90 °
Enclosure material		Aluminium cast / plastic
Degree of protection		IP 54
Installation position		Any installation position possible
Climate class	Operation	4K3, but -20 ... +80 °C, low temperature execution -40 ... +80 °C
	Storage	1K5, but -40 ... +80 °C
	Transport	2K4, but -40 ... +80 °C
Vibration resistance		< 10 g acc. to DIN 89011 Recommended continuous range for complete fittings ≤ 3 g
CE marking		Compliant with EG-EMV-rules 2014/30/EU and EC machinery rule 2006/24/EG
Controller data	Gain	max. 100
	Hysteresis	< 0,7 % of the control range
	Response level	< 0,5 % of the control range
	Nonlinearity	< 2 % of the control range
	Supply air influence	< 0,2 % / 0,1 bar, type 824.P < 0,1 % / 0,1 bar
Dimensions		See dimensional drawings figure 1 and 2
Weight	Type 824.P	Approx. 1,8 kg
	Type 824.E	Approx. 2,0 kg
	Pressure gauge block	Approx. 0,5 kg
Connections	Electric	In dependence of version 0 to 2 cable inlets M20 x 1,5
	Pneumatic with external pipe	Y and Z: collateral G ¼ DIN 45141, special version ¼"NPT
	Pneumatic with internal pipe	Z: collateral G ¼ DIN 45141, Y: behind G 1/8

Technical Data Sheet Positioner Type 824

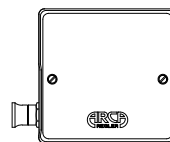

TD_824

Pneumatic data

Inlet air pressure		1,4...6 barg
Air quality	Solids	ISO 8573-1 Class 2 (particle size $\leq 1 \mu\text{m}$, particle density $\leq 10 \text{ mg/Nm}^3$)
	Dew point	ISO 8573-1 Class 2 (- 40 °C, min. 20 K below ambient temperature, low temperature execution < - 50 °C)
	Oil content	ISO 8573-1 Class 2 ($\leq 0,1 \text{ mg/Nm}^3$)
Air consumption		Type 824.E... < 0,6 Nm ³ /h at 1,4 bar g during stationary operation Type 824.P... < 0,5 Nm ³ /h at 1,4 bar g during stationary operation
Flow rate		6,0 Nm ³ /h at 1,4 barg

Electrical / pneumatic data basic device

	Pneumatic	Not explosion-proof
Electrical connection		Figure 3
Input signal	0,2 ... 1 bar	0 / 4 ... 20 mA
Split ranges	0,2 ... 0,6 ... 1 bar	0 / 4 ... 10 / 12 ... 20 mA
Load resistance		170 Ω
Required load voltage		3,4 V

Technical Data Sheet Positioner Type 824

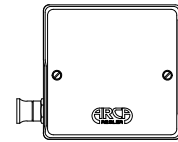

TD_824

Electrical data options – inductive limit switches

Version	824.P . . .	824.E . . .
---------	-------------	-------------

Limit switch N	824 - 1
Normal version	2 wire connection to DIN 19234 (NAMUR), for connected switching amplifier
2 slot initiators	Type SJ3,5-N
Function	Break contact (NC, normally closed)
Hysteresis	$\leq 1 \%$
Control loop	See connected switching amplifier
EMC acc. to	EN 60947-5-2 and DIN 19234
Electrical connection	Figure 4

Limit switch SN	824 - 2
Safety version	2 wire connection to DIN 19234 (NAMUR) for connected switching amplifier in safety version
2 slot initiators	Type SJ3,5-SN
Function	Break contact (NC, normally closed)
Hysteresis	$\leq 1 \%$
Control loop	See connected switching amplifier
EMC acc. to	EN 60947-5-2 and DIN 19234
Electrical connection	Figure 4

Limit switch E2	824 - 3
Direct switching version	3 wire connection with integrated switching amplifier
2 slot initiators	Type SB3,5-E2
Function	Make contact (NO, normally open)
Hysteresis	$\leq 1 \%$
Supply voltage	10...30 V DC
Max. load current	100 mA
Electrical connection	Figure 5

Technical Data Sheet

Positioner Type 824

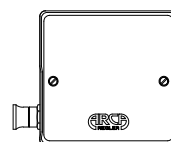

TD_824

Electrical data options – potentiometer and position feedback

Version	824.P ...	824.E ...
---------	-----------	-----------

Potentiometer	824	.					-				2
Resistance	200, 500 or 1000 Ohm ④										
Deviation of characteristic	≤ 2 % ⑤										
Internal capacitance C _i	3,5 pF										
Internal inductance L _i	10 μH										
Electrical connection	Figure 6										

Position transmitter 3w	824	.					-				3
3 wire connection	RWG, type 4522										
Supply voltage	15...24 V DC										
Output	4(0) - 20 mA, short-circuit resistant										
Current limitation	at ca. 28 mA										
Load resistance R _i	0 - 400 Ohm										
Deviation of characteristic	≤ 2 % ⑤										
Electrical connection	Figure 7										

Position transmitter 2w	824	.					-				4
2 wire connection	RWG, type TMT 136R										
Supply voltage	8,5 ... 36 V DC										
Output	4 - 20 mA, short-circuit resistant										
Current limitation	at ca. 36 mA										
Load resistance R _i	1300 Ohm at 36 V DC										
Deviation of characteristic	≤ 2 % ⑤										
Electrical connection	Figure 8										

- ① Valid ambient temperature at other loops on request.
- ② Special version to - 40° C (dew point < -50°C).
- ③ Special version NPT ¼".
- ④ Adjustment of zero point and range at receiver terminal.
- ⑤ Deviation of characteristic depends on mounting and stroke, max. 5 %.

Technical Data Sheet Positioner Type 824

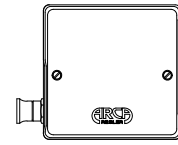

TD_824

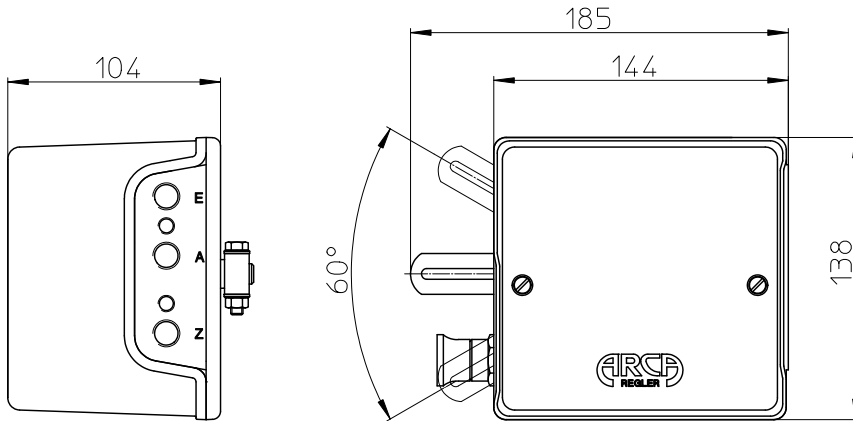

Figure 1 Dimensional drawing basic device type 824.P and 824.E

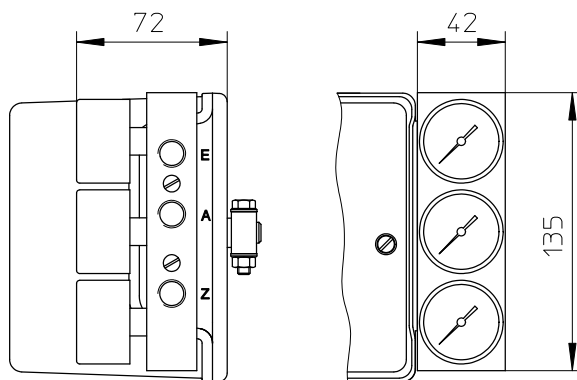
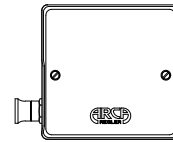
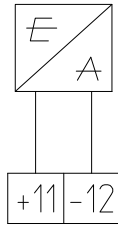

Figure 2 Dimensional drawing pressure gauge block

Technical Data Sheet Positioner Type 824



TD_824



4 – 20 mA

Figure 3 Electrical connection signal input basic device, type 824.E

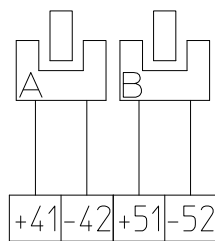

Figure 4 Electrical connection 2 wire limit switch (N and SN)

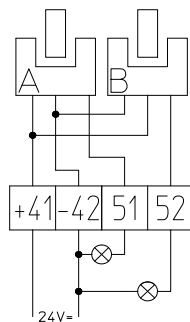

Figure 5 Electrical connection 3 wire limit switch (E2)

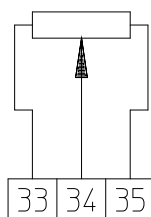
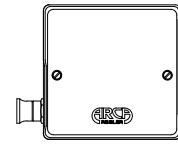

Figure 6 Electrical connection feedback potentiometer

Technical Data Sheet Positioner Type 824



TD_824

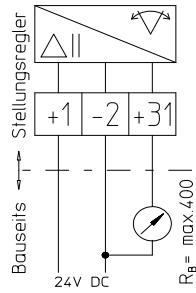

Figure 7 Electrical connection 3 wire position transmitter

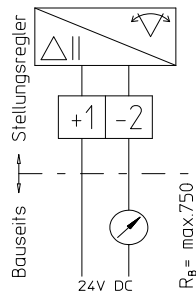
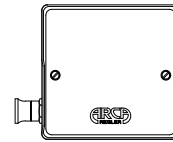

Figure 8 Electrical connection 2 wire position transmitter

Technical Data Sheet Positioner Type 824



TD_824

Order keys

8 2 4 . P 0 0 0 - 0 0 0

Series

Feedback	0	without
	1	./.
	2	Potentiometer
	3	Position transmitter 3 wire
	4	Position transmitter 2 wire
Limit switches	0	without
	1	inductive normal version SJ3,5-N
	2	inductive safety version SJ3,5-SN
	3	inductive direct switching SB3,5-E2
Pneumatic extra equipment	0	without
	1	pressure gauge block
For linear stroke / quarter turn	0	Stroke □ 20mm
	1	Stroke < 20mm
	3	Angle of rotation 90□
	4	Angle of rotation 60□
Input signal	0	0,2-1,0 bar
	1	4-20 mA
	2	0-20 mA
	3	0,2-0,6 bar
	4	0,6-1,0 bar
	5	4-12 mA
	6	12-20 mA
	7	0-10 mA
	8	10-20 mA
Output signal	1	single acting
	2	double acting
Operating mode	P	pneumatic
	E	electro-pneumatic, not explosion-proof